



HIGH  
QUALITY  
INSTRUMENTS  
CATALOGUE



**QUALITY BRAND**



INVENT GERMANY  
INOX CE

- ★ ISO 9001:2008
- ★ ISO 13485:2003
- ★ CE Mark
- ★ USA FDA cGMP

## TABLE OF CONTENT

01	Balling Guns	01
02	Bone Surgery	02-03
03	Castration instrumentnts	04-05
04	Ear Marking & Taging	06
05	Dehorners Instruments	07
06	Equine Dental Instruments	07-08
07	Farrier Tools	09-11
08	Grooming Equipment & Hoof Rasps	12
09	Hoof & Claw Instruments	13-17
10	Injectors & Extractors	18
11	Obstetrical Instruments	19
12	Plaster Instruments & Snake Catchers	20
13	Restraining Instruments	21-22
14	Ring Applicators & Teat Instruments	23
15	Vaginal Speculums	24
16	Snaffles. Dee. Ring Snaffle Bits	25-26
17	Spurs and Stirrups	27
18	Halters & Reins	28
19	Horse Measuring Sticks & Chariot Chains	29
20	Girths	30
21	Polo Wraps - Track Bandages	31
22	Seat Stick & Shipping Boots	32
23	Saddles	33
24	Horse Riding Gloves	34-35
25	Splint Boots and Whips Crops & Bats	36
26	Surgical Forceps & Towel Clamps	37
27	Dressing and Tissue Forceps, Hollowares, Scalpel Handles	38
28	Needle Holders & Scissors	39
29	Retractors	40
30	Equine Surgical & Miscellaneous Instruments	41
31	Root Elevators	42-43
32	Scalers, Probes, Dental Extraction Forceps and Mouth Retractors for Cats & Dogs	44





# Balling Guns



### 01-1001 Mini Balling Gun

Balling gun with spring clips 1.25" Metal head, brass : Length 14.75"



### 01-1002 Metal Head Balling Gun

Balling gun with 3" Metal head, brass: Length 17".



### 01-1003 Plastic Head Balling Gun

Balling gun with 2.5" Plastic head, brass: Length 17".



### 01-1004 Balling Gun

Balling gun with 5" Metal head, brass: Length 22".



### 01-1005 Rubber Head Balling Gun

Balling gun with spring clips 4" Rubber head, brass: Length 23.5".



### 01-1006 Pistol Balling Gun / Multi Bolus Balling Gun

Nickel-plated metal balling gun which holds up to six large boluses at one time. Uses a spring-action end-clip to secure boluses in barrel: Length 18.25".



### 01-1007 British Capsule Forceps

Excellent for capsuling sheep or horses. Stainless steel: Length 12".





## Bone Surgery

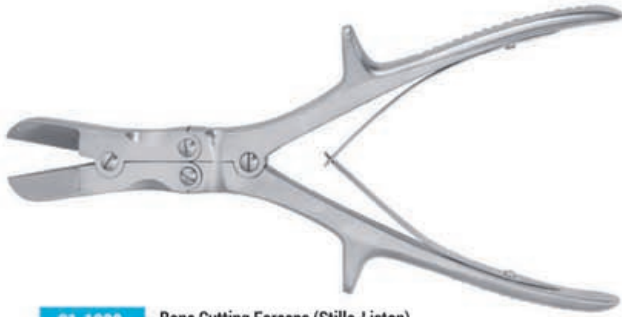

**01-1008** Bone Cutting Forceps (Stille-Liston)  
Also available in curved blade. Length 10.5"



**01-1009** Bone Cutting Forceps (Stille-Liston)  
Angled blades. Length 10.5"



**01-1010** Surgical Wire Cutters  
Forged from stainless steel and reinforced with tungsten carbide tip or specially

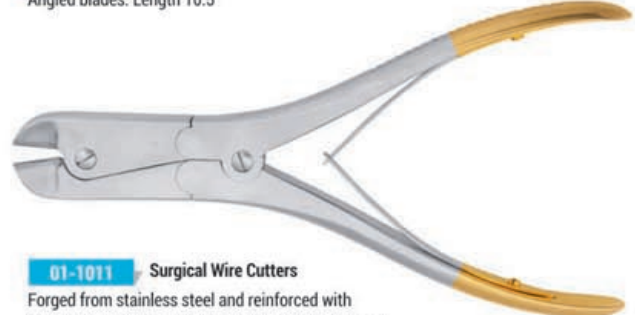

**01-1011** Surgical Wire Cutters  
Forged from stainless steel and reinforced with tungsten carbide tip or specially tempered tool steel. Size 9.25"



**01-1012** Bone Rongeur  
(Leksell-Stille) Length 9" s/s.

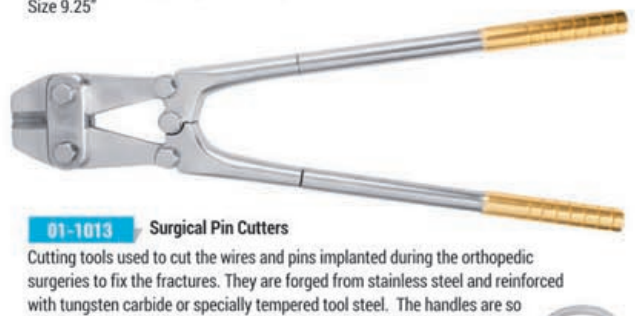

**01-1013** Surgical Pin Cutters  
Cutting tools used to cut the wires and pins implanted during the orthopedic surgeries to fix the fractures. They are forged from stainless steel and reinforced with tungsten carbide or specially tempered tool steel. The handles are so firm that they are able to provide more power for cutting and absorb the jerk of wire cutting. Length 18.5"

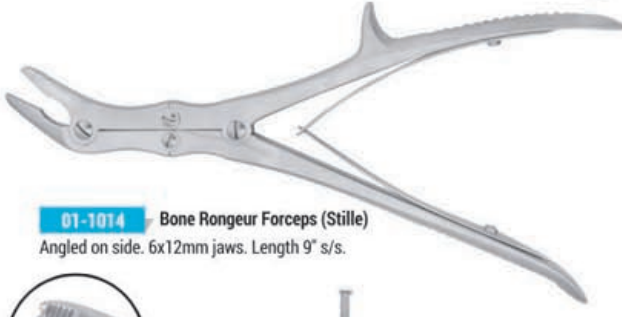

**01-1014** Bone Rongeur Forceps (Stille)  
Angled on side. 6x12mm jaws. Length 9" s/s.



**01-1015** Bone Holding Forceps (Verbrugge)  
Verbrugge bone forceps for holding / positioning re-positioning bone. Available sizes 10.5" s/s.



**01-1016** Bone Holding Forceps  
Length 11" s/s



**01-1017** Bone Holding Forceps (Lambotte)  
Lambotte bone holding forceps with ratchet. Available Sizes 8.5", 10", 13" s/s.

BS-2008



## Bone Surgery



**01-1018** Bone Holding Forceps  
Length 13.5" s/s.



**01-1019** Bone Holding Clamp Lowman  
Lowman bone clamp for holding, positioning, re-positioning bone. 1 x 2 Prong Jaws. Length 8" s/s.

## Branding Instruments



**01-1020** Revolving Head Tattoo Pliers  
Made of special aluminum alloy. Head holds four dies on each side, for a total of eight digits. Size 3/8" revolving head tattoo outfit.



**01-1021** Standard Tattoo Pliers  
Designed in the same general style as our regular cattle tattoos but reduced in size to make work more convenient with small animals. Head holds four dies, for a total of four digits. Size 3/8".



**01-1022** Small Tattoo Pliers  
Light weight pattern, designed for small animals. Made of aluminum alloy. Head holds four dies, for a total of four digits. Size 0.25".



**01-1023** Tattoo Letter Set 0-9  
Tattoo digits for Revolving head tattoo pliers and Standard tattoo pliers. Size 3/8". Tattoo digits for Small tattoo pliers. Size 0.25".



**01-1024** Aluminum Paint Branding Irons  
Made of aluminum castings, light in weight. Set consists of nine irons in 2.5" sizes. 0.5" depth, 1.5" width. Also available in 4" sizes. NOTE: A set 0-9 does not include the figure 9. The 6 iron can be reversed to make the figure 9.



**01-1025** Aluminum Tattoo Pliers  
The Aluminum Tattoo Pliers has a heavy duty spring for quicker release.



**01-1026** Tattoo Pliers  
Made of carbon steel.



**01-1027** Tattoo Pliers  
Two rows of tattoo digits can be inserted at a time. Made of carbon steel.



## Castration Instruments



**01-1028** Emasculatome 9" Castrator- Extra Small Size

These are precision-made instruments for the humane and bloodless castration of live stock by severing the testicular cord without injury to the bag (scrotum). Also Available with plastic and wooden grips. For lambs. Length 9".



**01-1029** Emasculatome 12" Castrator- Small Size

Also available with plastic grips. For lambs and young calves or for docking lambs tail. Length 12".



**01-1030** Emasculatome 14" Castrator- Medium Size

Also available with plastic grips. For calves and young bulls. Length 14".



**01-1031** Emasculatome 16" Castrator- Large Size

Also available with plastic grips. For mature bulls. Length 16"



**01-1032** Emasculatome 19" Castrator- X Large Size

Also available with plastic grips. For bulls, horses, buffalo, and camels. Length 19".



**01-1033** Large/Deluxe Castrating Band Applicator Aluminum

Heavy-duty aluminum ring applicator with notched expanding fingers to hold the ring. Useful on lambs, calves, goats and other animals



**01-1034** Castrating Band Applicator-Stainless Steel

For applying latex rings/bands used in tail docking and castration. The tapered nose prevents dirt build-up. Roller insures smooth operation: Length 8.75".



**01-1035** Castrating Band Applicator- Nickel Plated

For applying latex rings/bands used in tail docking and castration. The tapered nose prevents dirt build-up. Roller insures smooth operation: Length 8.75".

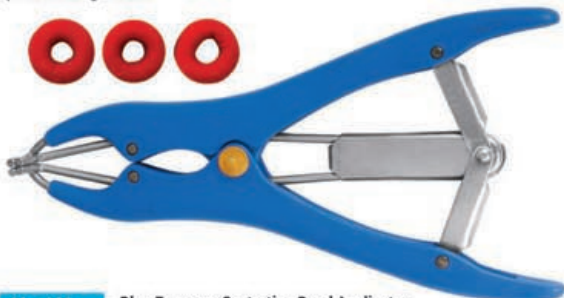

**01-1036** Blue Economy Castrating Band Applicator

Designed for quick and easy one-person operation. Lightweight blue plastic grips, textured for sure-grip, comfortable to use. Useful on lambs, calves, goats and other animals.



**01-1037** Crutch Knee Wrench - For Large Emasculatomes

The use of the crutch knee attachment makes possible a one-person operation with the larger emasculatome. Set consists of polished crutch attachment and spanner wrench. Fits 14", 16" and 19" emasculatomes only.



## Castration Instruments



**01-1038** Ear Docking

For dog's ear docking. Aluminum made. Straight, 12cm. Also available in curved.



**01-1039** Frank's Emasculator

Length 7-1/2", 9", 10-1/2" s/s.



**01-1040** Haussman's Emasculator

Double crush prevents primary and secondary hemorrhage because of the multiple crushing of the spermatic cord and artery. Sizes available 7-1/2", 9", 10", 11", 12" s/s



**01-1041** White's Emasculator

Length 7-1/2", 9", 10", 11", 12" s/s.



**01-1042** Haussman's Emasculator / Real Product

Curved, sizes available from 7-1/2", 9", 10, 11", 12" s/s.



**01-1043** Reimer's Emasculator

A very popular emasculator has a double crushing part. The cutting lever is worked separately. This allows extra time for crushing action and eliminates after bleeding: Length 12" s/s.



**01-1044** Serra's Emasculator Curved

A concave cutting plate draws the cord concentrically in to the jaws of the castrator. Reduces tissue slippage and post-op hemorrhage. Length 14" s/s



**01-1045** Serra's Emasculator Curved With Ratchet

It has curved non slip grips and positive crush for one hand use with ratchet: Length 14" s/s.



**01-1046** Serra's Emasculator With Ratchet

This newly designed instrument draws the cord concentrically into the jaws, thus preventing slipping of the cord. ratchet holds emasculator locked: Length 13-1/2" s/s.



**01-1047** Sand's Emasculator

Draws the cord concentrically in to the jaws, thus preventing slipping of the cord. Hemorrhage is reduced to a minimum ratchet holds forceps locked: Length 12" s/s



**01-1049** Gas Tail Docker

For quick, painless and economical tail docking of piglets. Stainless steel.



**01-1048** Castration Hook for Male cats



**01-1050** Newberry Castrating Knife

A stainless steel castrating knife will split the scrotum for easier removal of testicles with 2" blades. Overall Length 10.5".



## Ear Marking & Taging



**01-1051** Flower-Cut Ear Notcher  
The stainless steel construction with sharp, clean cut and slide spring action handle make these notchers ideal for identification purposes. Cuts notch 1" long. Length 8".



**01-1052** W-Cut Ear Notcher  
A high-quality, stainless steel ear notcher Cuts a "W" notch 0.70" long. Length 6".



**01-1053** U-Cut Ear Notcher  
A high-quality, stainless steel ear notcher Cuts a "U" notch 0.70" long. Length 6".



**01-1054** Small Ear Notcher With V-Cut  
A high-quality, stainless steel ear notcher Cuts a "V" notch 8mm/0.32" base x 16mm/0.63" long. Length 6".



**01-1055** Medium Ear Notcher With V Shape Die  
A high-quality, stainless steel ear notcher Cuts a "V" notch 12mm/0.47" base x 18mm/0.71" long. Length 6".



**01-1056** Large Ear Notcher With V Shape Die  
carefully ground after being hardened and tempered. Dies are not interchangeable. 20.85mm/0.82" cut. Length 9.37".



**01-1057** Ear Tag Applier



**01-1058** Plastic Tag Applier  
For applying plastic tags to the ears. Length 9".





## Dehorning Instruments



**01-1059** Dehorner Wooden Handle  
Wooden handle dehorner: Length 13" c/s.



**01-1060** Dehorner Metal Handle  
Straight metal handle dehorner with rubber grips: Length 13" c/s, c/p.



**01-1061** Dehorner Metal Handle  
Straight metal handle dehorner with rubber grips: Length 17" c/s, c/p.



**01-1062** Dehorner Metal Handle  
Straight metal handle dehorner with rubber grips. Heat-treated steel cutting blades: Length 13" c/s, c/p.

## Equine Dental Instruments



**01-1063** Tooth Cutter  
Hardened stainless steel simple joint lower molar cutters with permanent handles. Length 22" s/s.



**01-1064** Tooth Cutter  
Molar cutter with simple joint. Available in 3 different models.  
1) Closed Edges. / 2) Medium Gap. / 3) Wide Gap. Length 22" s/s.



**01-1065** Molar Forceps  
Length 18", 22" s/s.



**01-1066** Equine Molar Forceps-  
Gunter Tooth Forceps. Length 22" s/s.



**01-1067** Molar Forceps  
Serrated jaw creates good purchase on cheek teeth and premolar caps. A hugely versatile pair of forceps for every day use. Length 22" s/s.



**01-1068** Molar Spreader  
Used for loosening cheek teeth prior to extraction: Length 19", 22" s/s.



**01-1069** Molar Incisor Extractor  
These are designed to remove hard to get at rear molars but can also be used to remove incisors. Length 22" s/s.



**01-1070** Equine Compound Molar Cutter  
Stainless steel compound molar cutters with permanent handles. Powerful compound action. Available in 4 different models. 1) Fully Open Jaw. / 2) Closed Jaw. 3) Part Open Jaw. / 4) Part Open Jaw Angled. Length 24", 25", 26" s/s.



# Equine Dental Instruments



**01-1071** Wolf Tooth Forceps  
These extracting forceps are ideal for use in wolf teeth extractions and incisor cap extractions. Length 9" s/s.



**01-1072** Wolf Tooth Forceps / Extracting Forceps  
Knurled handles provide optimum grip even when wet. Length 10" s/s.



**01-1073** Cap Extractor  
Lower (Renold's) Length 17" s/s



**01-1074** Cap Extractor  
Upper (Renold's) Length 17" s/s.



**01-1075** Compound Rongeurs  
Stainless steel compound rongeur with offset head works well for wolf teeth, blind wolf teeth, incisor fragments and most tooth and cap slivers. Length 9" s/s.



**01-1076** Fulcrum Serrated Jaw Box Joint Forceps  
For extraction of first and second premolars or the number six and seven cheek teeth. This unit uses the hinge portion of the forceps for a fulcrum.



**01-1077** 3 Root Box Joint Forceps On Side  
With knurled handles. For molars with very little crown in aged horses and deciduous premolar caps. Length 19" s/s



**01-1078** 3 Root Box Joint Forceps Off Side  
With knurled handles. For molars with very little crown in aged horses and deciduous premolar caps. Length 19" s/s.



**01-1079** Dental Float Moveable  
Float comes with the moveable head with one wooden handle. With two screws in back to hold blade. Length 22".

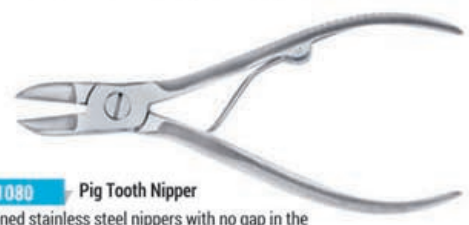

**01-1080** Pig Tooth Nipper  
Hardened stainless steel nippers with no gap in the jaws, construction with spring handle action. Also for cutting tails. Length 5" s/s.



**01-1081** Dental Float  
Combination float comes with both a straight and angled head. Length 10", with one wooden handle. Length 10.5". With two screws in back to hold blade. One rasp/rasp and one rasp/file in set. Length 20.5"



**01-1082** Equine Speculum By Schoupe  
Reduces the danger of slipping with this instrument since it is held in place by the equine cheek area. l



**01-1083** Bayer's Mouth Wedge  
Very handy when examining the oral cavity or doing dental work in equine, s/s.



## Farrier Tools



**01-1084** Hoof Nipper T.C Tip Modified  
A modified instrument which is forged from stainless steel and reinforced with tungsten carbide tip. Length 15". Also available in high carbon steel.



**01-1085** Hoof Nipper  
Particularly handy for farriers trimming larger feet or cob type horses with thicker walls. Forged from stainless steel. Length 15". Also available in high carbon steel.



**01-1086** Hoof Nipper  
Ideal for trimming away excess hoof wall or claws. Forged from stainless steel. Length 14". Also available in high carbon steel.



**01-1087** Hoof Nipper  
A very nice precision instrument, forged from stainless steel. Length 12".



**01-1088** Hoof Nipper  
Length 14". Also available in 12", 15" c/s.



**01-1089** Hoof Nipper  
Length 12". Also available in 14", 15" c/s.



**01-1090** Hoof Nipper Curved Blade T.C Tip Modified  
A modified instrument which is forged from stainless steel and reinforced with tungsten carbide tip. Length 15". Also available in 12", 14" c/s.



**01-1091** Hoof Nipper Curved Blade  
A modified instrument which is forged from stainless steel and has a curved blade. Length 15". Also available in 12", 14" c/s.



## Farrier Tools



**01-1092** Heavy Duty Hoof Nipper  
Fine quality steel hoof nipper with cushion grip handles. Length 15". Also available in 12", 14" c/s.



**01-1093** Hoof Nipper  
Designed exclusively to trim away excess hoof wall. Length 15". Also available in 12", 14" c/s.



**01-1094** Hoof Nipper  
Hoof nipper is used to trim away excess hoof wall. Vinyl handles give a comfortable feel in the hand. Length 15" c/s.



**01-1095** Hoof Nipper  
Hoof Nipper Length 12" c/s.



**01-1096** Shoe Puller And Spreader With T.C Tip Modified  
A combination shoe puller and spreader. Heat treated for strength. It is a modified instrument with a Tungsten Carbide tip. Length 13".



**01-1097** Shoe Puller And Spreader  
A combination shoe puller and spreader. Has exclusive pattern with sharp teeth on outside edges. Length 13" c/s.



**01-1098** Shoe Puller And Spreader  
Has exclusive pattern with sharp teeth on outside edges. For ease in spreading most shoe sizes and styles. Length 13" c/s.



**01-1099** Shoe Pullers (Pull-Offs)  
As sharp as a nipper so you can easily use it as a nail cutter. Length 15".



# Farrier Tools



**01-1100** Gooseneck Clincher  
Length 12" c/s. Also available in stainless steel.



**01-1102** Farrier Clincher  
For use on high and low nails. Used to roll over nails with curved jaw. Length 13" c/s. Also available in stainless steel.



**01-1104** Farrier Clincher  
For use with larger nails used in saddle horse hoofs to roll over and clinch nails. Oil quoting makes it rust resistant. Length 12" c/s. Also available in stainless steel.



**01-1106** Farrier Clincher  
For use with large nails used in saddles horse hoofs to roll over and clinch nails. Oil quoting makes it rust resistant. Length 12" c/s. Also available in stainless steel.



**01-1108** Cutting Nipper  
For cutting and pulling with cushion grip handles. Length 12" c/s. Also available in stainless steel.



**01-1110** Crease Nail Puller powder  
Coated Removes nails from crease of shoes that has been on horse for some time, 12" carbon steel powder coated. Also available in stainless steel.



**01-1112** Clinch Cutter  
Clinch cutter on one end and pritchel on opposite end s/s.



**01-1101** Low Nail Curved Jaw Clincher  
The curved jaw clincher features a proven design for excellent performance and reliability. Length 13" c/s. Also available in stainless steel.



**01-1103** Gooseneck Clincher  
Powder coating makes it rust resistant. Length 12" c/s. Also available in stainless steel.



**01-1105** Farrier Clincher  
To roll over nails with curved jaw. Red vinyl coated handle gives a comfortable grip. Length 13" c/s. Also available in stainless steel.



**01-1107** Cutting Nipper  
For cutting and pulling with cushion grip handles. Oil tempered and drop forged. Length 12" c/s. Also available in stainless steel.



**01-1109** Crease Nail Puller  
For the removal of nails when worn down inside the grooves of the shoe, 12" s/s



**01-1111** Shoe Spreader  
The design of this tool is simply a levering device with a differential length of arms on the head. The shoe there by opening it exactly where you want.



**01-1113** Clinch Cutter Powder Coated  
Clinch cutter on one end and pritchel on opposite end, Powder coated c/s.



**01-1114** Farrier Hammer



## Grooming Equipments



**01-1115** Horse Machine  
Removes unwanted whiskers and hairs. American pattern, Sand caste, Chromed.

**01-1116** Horse Machine  
Removes unwanted hair and whiskers from Horse & Cattle, Putor, German pattern. Red wooden handle.

**01-1117** Machine For Sheep  
Removes unwanted hair from Sheep Putor, German pattern, Red wooden handle.



**01-1118** Hand Clipper  
Spring type sheep shear (For Horse, Camel and Donkey)



**01-1120** Bot Egg Knife Plastic  
The safe efficient way to remove bot eggs. It has no sharp edges to gouge the horse and can be used by the youngest rider with safety. This bot egg knife is 8.75" long with a stainless steel blade.



**01-1121** Bot Egg Knife Wooden  
This bot egg knife is 8.75" long with a stainless steel blade and durable wooden handle.



**01-1122** Fetlock Shears  
Can be used in either hands with blades curving left or right. Stainless steel.



**01-1123** Post Mortem Scissor  
Heavy-duty scissors with one serrated edge. Sand caste, Stainless steel, length 7-3/4". Also available with black finished rings.

## Hoof Rasps



**01-1124** Flat Rasp  
A flat rasp with rasp cut on one side and double cut file on other. Super sharp. Length 36cm c/s.



**01-1125** Flat Rasp  
A flat rasp with rasp cut on one side and double cut file on other. Super sharp. Length 36cm c/s.



**01-1126** Hoof Rasp X Style  
Rasp teeth on one side with file teeth on other. Length 31cm c/s.



**01-1127** Hoof Rasp X Style  
Rasp teeth on one side with file teeth on other. Length 31cm c/s.



**01-1128** Hoof Rasp  
Rasp teeth on two side with file teeth on other. Length 31cm c/s.



**01-1129** 4-Way Hoof Rasp  
The file has different filing grades: fine, medium fine, medium. This allows you to file the hooves to proper length while shaping and smoothing the rough and sharp edges. The 4-Way Hoof Rasp is the best tool for smoothing all areas of the animal's hooves. Length 35cm c/s.



## Hoof & Claw Instruments



**01-1130** Hoof Tester

Test hoof hardness with this popular, steel hoof tester with scored edges for better gripping. Available sizes 13", 13.25", 16" s/s.



**01-1131** Hoof Tester Heavy Duty

Available sizes 13", 13.5" s/s.



**01-1132** Hoof Tester

Length 16" s/s.



**01-1133** Large Hoof Tester

The large model has 12" reins, is 19" long and opens to 9.5". Stainless steel with pointed teeth.



**01-1134** Small Hoof Tester

The small model has 9" reins, is 15" long and opens to 7". Stainless steel with pointed teeth.



**01-1135** Large Modified Hoof Tester

The modified model has 12" reins, is 19" long and opens to 9.5". Stainless steel with reduced teeth.



**01-1136** Hoof Trimmer

Durable steel with bolted construction. Green protective coating covers the steel. 1-1/4" opening between trimmer blades with double compound action. Sharp blades are firmly attached with three recessed screws. Black rubber grip handles. Length 17" c/s.



**01-1137** Nail Clipper

A nail clipper with sure-grip handles for cutting dogs nails. Stainless steel blades are designed to give precision cutting action. Flip-open safety lock protects cutting edge when not in use. 6-3/8" long.



## Hoof & Claw Instruments



**01-1138** Foot Rot Hoof Shear Carbon Steel  
Carbon steel handles: Length 9.5".



**01-1139** Foot Rot Hoof Shear Aluminum  
Ideal for both sheep and goat. Length 9.5".

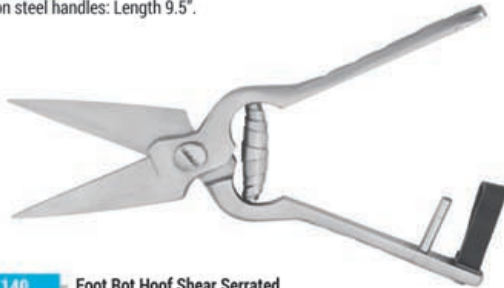

**01-1140** Foot Rot Hoof Shear Serrated  
Primarily used for sheep: Length 9" s/s.



**01-1141** Foot Rot Hoof Shear Plane  
Available with plane blades and in leather holster 9" s/s.



**01-1142** Trimming Shears  
Red enameled handles with extra-large double bow Length 14".



**01-1143** Single Bow Economy Sheep Shears  
6" shearing blades. Overall Length 12".



**01-1144** Hoof Pick-Vinyl Coated Handle  
Sturdy, vinyl coated handle: Length 5.5" s/s.



**01-1145** Hoof Pick Large - Vinyl Coated Handle  
Pick with vinyl coated handle, s/s.



**01-1147** Hoof Knife Kit  
Available in compact, elegant leather case with zipper. Set includes Wooden handle with 4 different types of Interchangeable blades.



**01-1146** Hoof Pick  
Chrome plated steel rod hoof pick with a screw driver end which can be used to tighten Chicago screws.



**01-1148** Hoof Knife Kit  
Available in compact, elegant leather case with zipper. Set includes Wooden handle with 6 different types of Interchangeable blades.





# Hoof & Claw Instruments

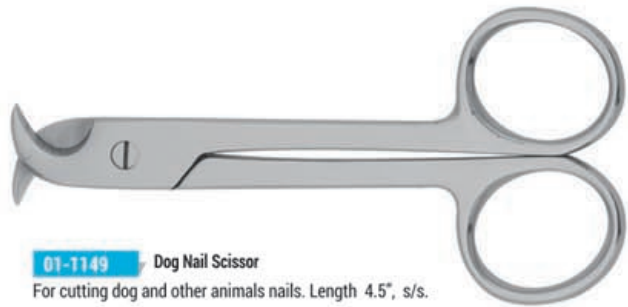

**01-1149** Dog Nail Scissor  
For cutting dog and other animals nails. Length 4.5", s/s.



**01-1150** Cat Nail Scissor  
For cutting cat nails. Length 3.5", s/s.

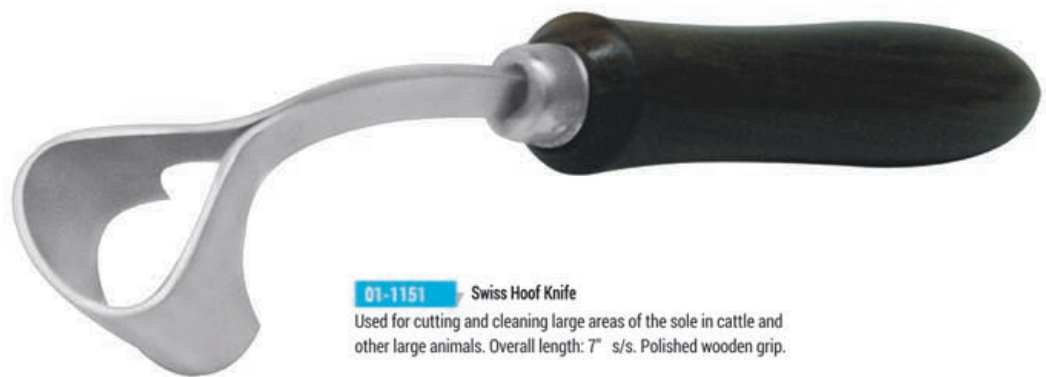

**01-1151** Swiss Hoof Knife  
Used for cutting and cleaning large areas of the sole in cattle and other large animals. Overall length: 7" s/s. Polished wooden grip.



**01-1152** Hoof Knife  
Double edged. Length 7.5" s/s. Polished wooden grip.



**01-1153** Hoof Knife Small Size  
Double edged. Length 6.5" s/s. Polished wooden grip



**01-1154** Oval Hoof Knife  
Available in wooden handle, can be used left or right handed.  
Extra long shaft makes it easier and more accurate to use



**01-1155** Oval Hoof Knife  
Available in wooden handle, can be used left or right handed.



# Hoof & Claw Instruments



Right **01-1156** Left

### Hoof Knife Regular

Regular blade. This durable blade is held by two rivets in the hardwood handle and it extends 2" into handle. 1/2" blade at heel, 3" long. 8.5" long overall. Wooden grip. Available in left and right handed grip.



Right **01-1157** Left

### Hoof Knife

Double edged. Polished wooden grip. Available in left and right handed grip.



Right **01-1158** Left

### Hoof Knife

Polished wooden grip. Available in left and right handed grip.



Right **01-1159** Left

### Hoof Knife

Narrow blade, Polished wooden grip. Available in left and right handed grip.



Right **01-1160** Left

### Hoof Knife

Double edged. Polished wooden grip. Available in left and right handed grip.



Right **01-1161** Left

### Hoof Knife

Curved blade. Polished wooden grip. Available in left and right handed grip



Right **01-1162** Left

### Hoof Knife

Extra long shaft makes it easier and more accurate to use. Polished wooden grip. Available in left and right handed grip.



Right **01-1163** Left

### Hoof Knife

Narrow blade. Fine wooden grip. Available in left and right handed grip.



## Hoof & Claw Instruments



Right **01-1164** Left

**Hoof Knife**  
Wide blade. Fine wooden grip.  
Available in left and right handed grip.



Right **01-1165** Left

**Hoof Knife**  
Regular blade. Plastic grip.  
Available in left and right handed grip.



Right **01-1166** Left

**Hoof Knife**  
Double edged. Plastic grip.  
Available in left and right handed grip.



Right **01-1167** Left

**Hoof Knife**  
Double edged. Plastic grip.  
Available in left and right handed grip.



Right **01-1168** Left

**Hoof Knife**  
Narrow blade. Plastic grip.  
Available in left and right handed grip.



Right **01-1169** Left

**Hoof Knife**  
Narrow blade. Double edged. Plastic grip.  
Available in left and right handed grip.



Right **01-1170** Left

**Hoof Knife Backolyte Grip**  
Narrow blade. Backolyte grip.  
Available in left and right handed grip.



## Injectors & Extractors



### 01-1171 Europlex Syringe

Europlex metal gun syringe 30ml, 50ml sizes  
(Also available with casing).



### 01-1172 Europlex Syringe

Europlex metal gun syringe 30ml, 50ml sizes  
(Also available with casing).



### 01-1175 Automatic Syringe

Automatic Syringe  
Available sizes: 5ml, 10ml, 15ml



### 01-1173 Bloat Trocar

The flat-to-round shape has made this wooden-handled trocar very popular for venting animal gas accumulations. Includes stainless steel cannula and protector cap. Cannula length is 6". Also available in 5" length.



### 01-1174 Cattle Trocar

This cattle trocar is used to relieve bloating. Complete with cannula, a hollow tube which remains when trocar is withdrawn to allow gas to escape. Stainless point. Metal handle 9.5" L. Tube is 5-1/2" L. 3/8" I.D.



### 01-1176 Automatic Syringe

Automatic Syringe  
Available sizes: 30ml



### 01-1177 Automatic Syringe

Automatic Syringe  
Available sizes: 60ml



### 01-1178 Semi Auto Syringe

Semi Auto Syringe  
Available sizes: 70ml



### 01-1179 Semi Auto Syringe

Semi Auto Syringe  
Available sizes: 150ml



## Obstetrical Instruments



**01-1180** Krey Hook  
Length 8" s/s.



**01-1181** Linde's Embryotomy Knife  
Length 5" s/s



**01-1182** Ostertag's Eye Hook Blunt  
Length 2", Hole Diameter 5/8"  
and Hook Length 3/4" s/s.



**01-1183** Moore's OB Chain Handle  
Stainless steel OB handle with one-piece construction. 5.5"



**01-1184** Moore's OB Chain Handle  
With Plastic Grip Handle aids in use of chains. 5.5" s/s.



**01-1185** OB Wire Guide  
The instrument will bring your wire around any tight or difficult location on the fetus. Length 7" s/s.



**01-1186** OB Chain  
Heavy duty obstetrical chains assist in the delivery of the calves. Length 60" s/s.



**01-1187** OB Chain  
Heavy duty obstetrical chains assist in the delivery of the calves. Length 30" s/s.



**01-1188** Swine Cable OB Snare  
This durable, swine cable obstetrical snare is made from aircraft cable. Overall length 18" s/s.



**01-1189** OB Wire Guide  
The instrument will bring your wire around any tight or difficult location on the fetus. Length 9" s/s.



**01-1190** Sutter OB Handle  
Knurled non-slip grip. Length 4" c/s.

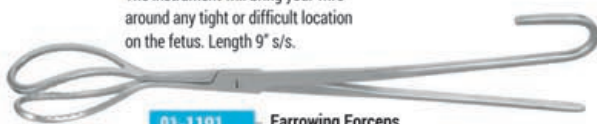

**01-1191** Farrowing Forceps  
Farrowing Forceps For Piglets. Length 20.5" s/s.



**01-1192** Farrowing Snare  
Shaped end allows operator to direct head after cable is placed behind ears or legs. Length 15" c/s.

## Plaster Instruments



**01-1193** Cast Spreader  
Cast spreaders with 5cm wide blades. Available sizes 10.5", 11" s/s.



**01-1194** Cast Spreaders (Henning)  
3-Pong cast spreader 9". Spring-loaded handle for one-hand operation. cutting beyond cast thickness.

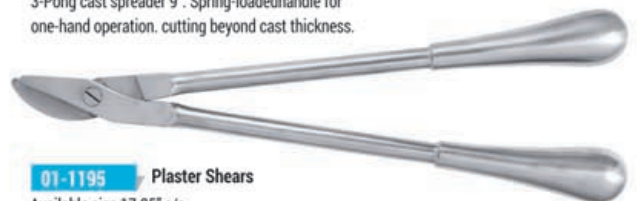

**01-1195** Plaster Shears  
Available size 17.25" s/s.



## Plaster Instruments



**01-1196** Plaster Shears  
Plaster shears with serrated blades.

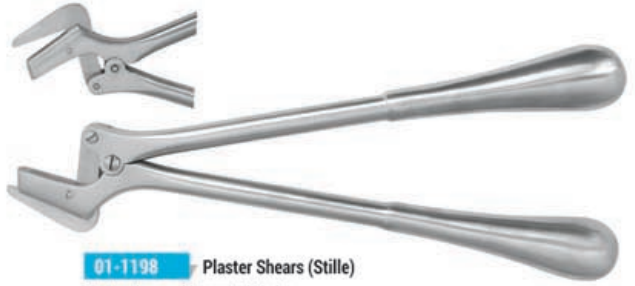

**01-1198** Plaster Shears (Stille)  
Plaster shears with serrated blades.  
Available sizes 9", 10" 15" s/s.



**01-1197** Plaster Shears (Brun/Bohler)  
They can cut through cloth, plastic and metal. They have serrated blades for non-slip cutting. Stainless steel. Length 10"



**01-1199** Ring Cutter 16 cm



**01-1200** Universal Scissors  
It can cut through almost anything: a multitude of uses around any clinic. Autoclavable.  
Stainless steel: Length 7.5", 5.5".

## Snake Catchers

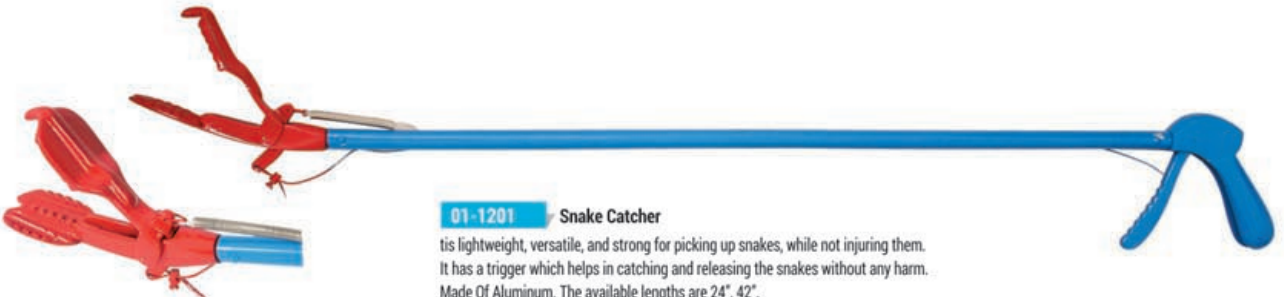

**01-1201** Snake Catcher  
It is lightweight, versatile, and strong for picking up snakes, while not injuring them. It has a trigger which helps in catching and releasing the snakes without any harm. Made Of Aluminum. The available lengths are 24", 42".



**01-1202** Snake Hook  
Made of Aluminum. The rubber grip increases the hold in case of a wet conditions. The available lengths are 24", 30", 36", 48".



## Restraining Instruments



**01-1203** Premium Hog Holder With Lock  
An improved hog holder made of 3/16" galvanized aircraft cable with a cable stop that avoids kicking. Durable, high-strength tubing of carbon steel, nickel-plated.



**01-1204** Ring-O-Matic Hog Catcher  
Snares and holds any weight hog. Loop is constructed of galvanized aircraft cable and the handle is coated with a rust-resisting finish. Handle is 22" in length with a 20" loop of aircraft cable.



**01-1205** Shorty Hog Holder  
Easy, quick way to control pigs in tight spaces. Comfort-grip rubber handle with galvanized aircraft cable loop. Approximately 8" long.



**01-1206** Canine Mouth Gag  
Spring action with nylon inserts for less trauma. Three sizes available: Small: 4.5" s/s, Medium: 5.75" s/s, Large: 6.25" s/s.  
R-1615



**01-1207** Cattle Twitch / Nose Twitch  
For help in restraining horses or cattle. Nylon coated handles for firm grip. Length 17" s/s.



**01-1208** Bull Holder  
Stainless steel sand casted. PVC grip. Available sizes 14", 15" s/s.



**01-1209** Bull Lead With Chain  
Place stainless steel lead into animal's nostrils and close gently. Secure handles with heavy-duty 13 1/2" chain. Also available without chain.



**01-1210** Harm's Bull Holder  
Made of Stainless steel.



**01-1211** Cattle Leader Aluminum  
The ideal type lead for show animals - gives the nose a shorter appearance than other type leads. Made of strong, Permits animal to eat without removal. 2-1/2" x 1-1/4" x 3-3/4" L.



**01-1212** Cattle Leader Brass  
The ideal type lead for show animals - gives the nose a shorter appearance than other type leads. Permits animal to eat without removal.



**01-1213** Heavy Duty Bull Lead  
With coiled spring and protective release sleeve. Made of Stainless Steel.



**01-1214** Kantslip Cattle Lead  
Made with fine quality holding spring. Opens to approximately 2-5/8". Overall width 3", overall length 5" brass, c/p.



## Restraining Instruments



**01-1215** Shepherds Crook Neck & Leg Model  
It has a 2 way use and rubber grips for strong hold. Length 57".



**01-1216** Shepherds Crook Leg Model  
It has rubber grip for strong hold. Length 53".



**01-1217** Calf Weaner Plastic  
Durable red plastic, more comfortable for livestock. Flexible material and a fixing screw ensure easy adjustment and a perfect fixing in the cattle's nose.



**01-1218** Milk Sucking Preventor / Calf Weaner Metal  
Guard swings free allowing animal to eat and drink freely, yet prevents sucking. Nose piece is adjustable to nose separation of the animal then locked in place by tightening the wing nut, Aluminum.



**01-1219** Milk Sucking Preventor / Calf Weaner Metal  
Guard swings free allowing animal to eat and drink freely, yet prevents sucking. Made of Aluminum.



**01-1220** Anti Kick Device  
Made of silver, sand-cast, powder coated, screw made of carbon steel.



**01-1221** Dog Muzzle A - B  
This well-fitting, comfortable muzzle is made based on special strong metallic construction to maintain the shape of the muzzle and to assure long life for the muzzle. Powder coating makes this muzzle rust resistant. Due to great design the muzzle provides the dog with best ventilation. Also available in stainless steel without powder coating.



**01-1222** Dog Muzzle A - B



**01-1223** Anti Kick Bar / Kick-Stop Cow Immobilizes  
Fits any size animal by means of an easy, push button. Just slip over back and thigh area and push the button to reach proper adjustment. When in position, the animal will not kick its hind legs.



**01-1224** Equivet Full Mouth Speculum  
Made of Stainless steel sand-cast. Adjustable straps for secure fit to the horse. Stainless steel spring loaded ratchets on both sides of speculum keep the mouth open at the desired setting during use. This sturdy full mouth speculum comes with upper and lower tooth plates.





## Ring Applicators



**Clips**  
Sizes No.3, No.4, No.5, No.6

Set of 100

### 01-1225 Snout Pig Ring Applicator

Sand cast, Stainless steel snout pig ring applicator. Length 6" s/s.



Rings

Sizes: 20 mm 25 mm 30 mm 40 mm

### 01-1226 Nose Ring Applicator

Make pig ringing quick, easy and painless. Rings go between nostrils. Length 10".



### 01-1227 Bull Nose Punch

For piercing the bull's nose cartilage prior to insertion of the nose ring. This tool makes the job more animal friendly.



### 01-1228 Bull Ring Applicator Economy

This metal applicator will do rings up to 77mm x 10mm (3 inch) Length overall is 11".



### 01-1229 Bull Ring Applicator Heavy Duty

Stainless Steel bull ring applicator. Excellent Quality. This is a far superior product than the standard steel applicators.



### 01-1230 Bull Ring Stainless

The special sharp cutting points pierce the nasal septum easily with no pre-incision. Size's Available: 2", 2.5", 3", 3.5".



### 01-1231 Bull Ring Brass

Brass bull ring is self-piercing and extremely durable. A long, sharp piercing point ensures a clean cut. Size's Available: 2", 2.5" 3", 3.5"

## Teat Instruments



### 01-1232 Teat Slitter

Opens test sphincter for greater milk flow. Available with loops. Length 8", brass and s/s.

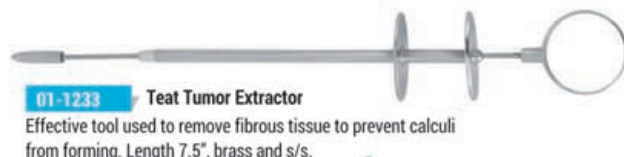

### 01-1233 Teat Tumor Extractor

Effective tool used to remove fibrous tissue to prevent calculi from forming. Length 7.5", brass and s/s.



### 01-1234 Hug's Teat Tumor Extractor

Effective tool used to remove fibrous tissue to prevent calculi from forming: Length 6", brass and s/s.

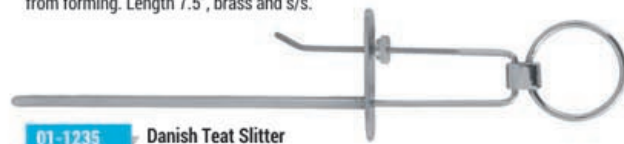

### 01-1235 Danish Teat Slitter

Extra thin model. Blades are opened by loosening the small burr on side of the instrument: Length 7.5", brass and s/s.



### 01-1236 Cornell teat curette

Stainless steel with spiral cutting edge 6"



### 01-1237 Teat Syphons

Milking Tube Length 3.75", brass and s/s.



### 01-1238 Hug's Teat Knife / Teat Lancet

Length 6", blade 0.5", s/s.



### 01-1239 Sudan Blood Taking Needle

Length 3.5", brass and s/s.



### 01-1240 Milking Tube

Length 4.25", brass and s/s.



## Vaginal Specula



**01-1241** Polansky

3 Blades for wide exposure. Butterfly screw with 2 blades.  
Blades Length 27cm, Overall Length 35 cm, Max. opening 10 cm, s/s.

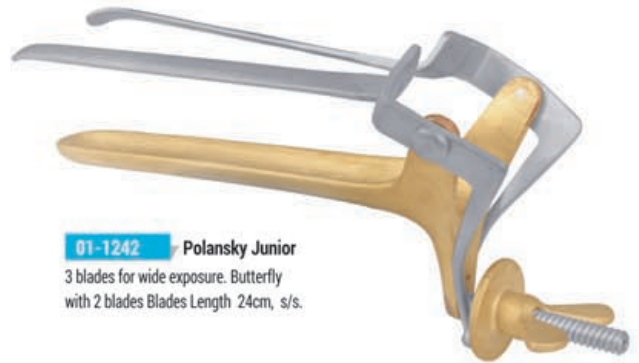

**01-1242** Polansky Junior

3 blades for wide exposure. Butterfly with 2 blades Blades Length 24cm, s/s.



**01-1243** Winterton

Blades Length 10cm, s/s.



**01-1244** Russian

Blades Length 23cm, s/s.



**01-1245** Graves

Blades Length 15cm, s/s.



## Snaffles. Dee. Ring Snaffle Bits



**02-1246** Rings stainless steel  
4" to 5-1/2" mouth size available. Ring varies from 45mm to 75mm.



**02-1247** Rings stainless steel  
Mouth and rings made of stainless steel.



**02-1248** Rings stainless steel  
Rings stainless steel. Mouth german steel.



**02-1249** Rings stainless steel  
Rings stainless steel. Mouth carbon steel with leather cover.



**02-1250** Rings stainless steel  
Stainless steel rings. Mouth made of rubber.



**02-1251** Rings stainless steel  
D bit with 5" rubber covered mouth. Stainless steel. Also available in chrome plating.



**02-1252** D ring snaffle  
made of stainless steel. 4-1/2" to 5-1/2" mouth sizes available.



**02-1253** Rings stainless steel  
Stainless steel. mouth made of german steel including chain.



**02-1254** Rings stainless steel  
Rings and mouth made of stainless steel.



**02-1255** Ring Stainless steel  
Stainless steel rings. Link and mouth made of stainless steel.



**02-1256** Ring Stainless steel  
Stainless steel rings. Link made of red copper. Stainless steel mouth.



**02-1257** Ring Stainless steel  
Stainless steel rings. Link and mouth made of red copper.



**02-1258** Ring Stainless steel  
Brass rings. Link and mouth made of brass.



**02-1259** Ring Stainless steel  
Stainless steel.



**02-1260** Ring Stainless steel  
Stainless steel. Mouth made of german steel.



**02-1261** Ring Stainless steel  
Stainless steel.



**02-1262** Ring Stainless steel  
Stainless steel.



**02-1263** Ring Stainless steel  
Stainless steel. Mouth german steel including chain.



**02-1264** Ring Stainless steel  
Stainless steel.



**02-1265** Ring Stainless steel  
Link german silver. Mouth made of stainless steel.



**02-1266** Ring Stainless steel  
Stainless steel pelham including chain.



## Snaffles. Dee. Ring Snaffle Bits



**02-1267** Snaffle Bits  
Stainless steel including chain.



**02-1268** Snaffle Bits  
Stainless steel. Link german steel including chain.



**02-1269** Snaffle Bits  
Rings stainless steel. Mouth german steel.



**02-1270** Snaffle Bits  
Rings and mouth made of stainless steel.



**02-1271** Snaffle Bits  
Stainless steel including chain.



**02-1272** Snaffle Bits  
Rings stainless steel. Rubber covered mouth.



**02-1273** Snaffle Bits  
Stainless steel including chain.



**02-1274** Snaffle Bits  
Stainless steel hollow mouth including chain.



**02-1275** Snaffle Bits  
Stainless steel.



**02-1276** Snaffle Bits  
Stainless steel.



**02-1277** Snaffle Bits  
Full cheek with stainless steel mouth.



**02-1278** Snaffle Bits  
Stainless steel.



**02-1279** Snaffle Bits  
Stainless steel.



## Spurs and Stirrups



**02-1280** Spurs Stainless Steel  
Stainless steel spurs with brass buttons and rowel.  
Also available in chrome plating. 2pcs set.



**02-1281** Spurs Stainless Steel  
Stainless steel spurs. 2pcs set.



**02-1282** Spurs Stainless Steel  
Classic hunt and jump spurs in the popular  
loop end style. Stainless steel. 2pcs set.



**02-1283** Spurs Stainless Steel  
Fine engraving with loop end style.  
Stainless steel. 2pcs set.



**02-1284** Spurs Stainless Steel  
Stainless steel spurs. Gold plated. 2pcs set.



**02-1285** Spurs Stainless Steel  
Carbon steel spurs with powder coating. Buttons  
and rowel made of brass.



**02-1286** Spurs Stainless Steel  
Carbon steel spurs powder coated with brass buttons.  
16 point rowel. 2pcs set.



**02-1287** Spurs Stainless Steel  
Brass spurs with 10 point rowel. 2pcs set.



**02-1288** German steel stirrup  
Including rubber, 2pcs set.  
Sizes Available: 4", 4 1/4", 4 1/2", 4 3/4", 5".



**02-1289** Stainless steel stirrup  
Including rubber, 2pcs set.  
Sizes Available: 4", 4 1/4", 4 1/2", 4 3/4", 5".



**02-1290** Stirrup  
Stainless steel stirrup, flexible.  
Including rubber, 2pcs set.



**02-1291** Stainless steel stirrup  
Including rubber, 2pcs set.  
Sizes Available: 4", 4 1/4", 4 1/2", 4 3/4", 5".



**02-1292** Stainless steel stirrup  
Including rubber, 2pcs set.  
Sizes Available: 4", 4 1/4", 4 1/2", 4 3/4", 5".



**02-1293** Stainless steel stirrup  
Stainless steel stirrup, including rubber, 2pcs set.  
Sizes Available: 4", 4 1/4", 4 1/2", 4 3/4", 5".



**02-1294** Stainless steel stirrup  
Stainless steel stirrup, including rubber, 2pcs set.  
Sizes Available: 4", 4 1/4", 4 1/2", 4 3/4", 5".



**02-1295** Stainless steel stirrup  
Especially designed for polo players.  
Sizes Available: 4", 4 1/4", 4 1/2", 4 3/4", 5".



**02-1296** Rubber for stirrups  
Rubber for stirrups. 2pcs set.



## Halters & Reins



**02-1297** Halters & Reins  
Nylon halter for cows.



**02-1298** Halters & Reins  
Genuine leather halter with brass rings.



**02-1299** Halters & Reins  
Genuine leather halter with brass rings.



**02-1300** Halters & Reins  
Fancy halter with brass c/p rings, Genuine leather.



**02-1301** Halters & Reins  
Bridle made of genuine leather. Including rein.



**02-1302** Halters & Reins  
Leather bridle including rein made of cotton.



**02-1303** Halters & Reins  
Leather bridle including rein made of leather.



**02-1304** Halters & Reins  
Rein made of cotton 100" to 110".



**02-1305** Halters & Reins  
Rein made of leather 100" to 110".



**02-1306** Halters & Reins  
Leather stirrup 52" to 58".



**02-1307** Halters & Reins  
Nylon halter with brass plated hardware.  
Available sizes: Small, Medium, Large.



**02-1308** Halters & Reins  
Nylon halter with c/s, c/p hardware.  
Available sizes: Small, Medium, Large.



**02-1309** Halters & Reins  
Nylon halter with c/s, c/p hardware.  
Available sizes: Small, Medium, Large.



## Horse Measuring-Walking Sticks & Hinge Cribbing



**02-1310** Horse Measuring-Walking Sticks

Made of cane and Aluminum. Measure extends to 18hh, extending arm with spirit level. Ideal for measuring horses.

**02-1311** Horse Measuring-Walking Sticks

Made of cane and Aluminum. Measure extends to 18hh, extending arm with spirit level. Ideal for measuring horses.

**02-1312** Hinge Cribbing With Leather Strap

Made of Aluminum. Quality leather adjustable strap. Double and sewn. Durable steel buckle. Also available with nylon strap.



## Arctic Quilt Blankets



**02-1313** Arctic Quilt Blankets

Outer layer parachute. Filled with polyester and foam. Lining polyester. Available sizes 47", 63" and 70". Available colors: Green/red trim, Black/red trim, Red/black trim, Grey/black trim, Sky Blue/ sky blue trim, Black/white trim, Green/white trim, Navy Blue /white trim, Red/white trim, White/black trim, Royal Blue white trim, Maroon/white trim . SPECIFY COLOR.



**02-1314** Arctic Quilt Blankets

Made of pure cotton. Available colors: Black/red trim, Red/black trim, Grey/black trim, Sky Blue sky blue trim, Black/white trim, Green/white trim, Navy Blue /white trim, Red/white trim, White black trim, Royal Blue/white trim, Maroon/white trim . SPECIFY COLOR.

## Chariot Chains



**02-1315** Chariot Chains

Stainless steel, Length 40".



**02-1316** Chariot Chains

Stainless steel, Length 40".



**02-1317** Chariot Chains

Stainless steel, Length 40".



**02-1318** Chariot Chains

Stainless steel, Length 40".



## Girths



**02-1319** Cotton Girth

Made with a special soft cotton cover and comfortably padded. Heavy nylon straps, washable. Specify size and color 46" to 54". Black, Brown and Chestnut. Elastic ends.



**02-1320** Cotton Girth

Made of finest cotton web. Excellent for show horses or a good school girth. Specify size 46" to 54".



**02-1321** Cotton Girth

Made of finest cotton web. Specify size 46" to 54".



**02-1322** Cotton Girth

Made of finest cotton web. Specify size 46" to 54".



**02-1323** Leather Girth

Quality leather girth with belly guard to protect horse from injury. Elastic ends. Carbon steel c/p roller buckles. Black and Brown. 46" to 54". Specify size.



**02-1324** Cotton Girth

Plain end leather girth. Specify size and color 46" to 54". Black, Brown.



**02-1325** Cotton Girth

Made of premium quality leather with a reinforcing strip stitched down the back and elastic at both ends. With four buckles. Size 46" to 54".



**02-1326**

Leather Girth

Genuine leather with elastic at one end. Specify size and color 46" to 54". Black, Brown.



**02-1327**

Dressage Girth

Dressage style girth made of softchoice leather in black. Designed for long billet saddles. Specify size and color 46" to 54". Black, Brown.



**02-1328**

Dressage Girth

Dressage girth, Genuine leather. Specify size and color 46" to 54". Black, Brown.





## Polo Wraps-Track Bandages



02-1329



### Polo Wraps / Track Bandages

A quality bandage for racing, hunt and polo. Elastic support combined with fleece makes this bandage not only protective but resilient and shock resistant. 5" wide 4 meter. Packed per set of 4.



02-1330



## Lunge Lines



02-1331



02-1332

### Nylon Lunge Lines

Made of 1" wide poly web. 26 feet length. Heavy duty carbon steel chrome plated and brass snap.



02-1333



02-1334



### 02-1335 Cotton Lunge Lines

Heavy ribbed cotton webbing that is easy to grip and comfortable to the hands. Heavy duty chrome plated and brass snap.



### 02-1336 Leather Lunge Lines

Heavy ribbed Leather webbing that is easy to grip and comfortable to the hands. Heavy duty chrome plated and brass snap.



### 02-1337 Cotton Lunge Lines

Made of 1" wide poly web. 5 feet length. Brown, Blue, Orange, Navy, Blue, Green, Red and Black. Specify color. Heavy duty carbon steel chrome plated snap.

## Cattle Lead & Rope Hag Nets



### 02-1338 Cattle Lead

Hook made of steel and brass. Length 6 feet.



### 02-1339 Cattle Lead

Hook made of steel and brass. Length 6 feet.



### 02-1340 Rope Hay Nets

White cotton which is much safer than nylon. Perfect for your horse trailer and around the barn.



## Seat Stick & Shipping Boots



**02-1341** Seat Stick

Light weight metal. Hinged ground plate to prevent sinking in soft ground. Excellent for shows, rallies etc.



**02-1342** Seat Stick

Light weight metal. Hinged ground plate to prevent sinking in soft ground. Excellent for shows, rallies etc.



**02-1343** Shipping Boots

Contour fit and super thick to provide ultimate security, protection and comfort. Color Available Grey, Dark Grey, Royal Blue, Navy Blue.

## Saddle Pads & Dog Belts



**02-1344** QUILTED COTTON COMFORT SADDLE PADS

100% Cotton twill pad featuring an inner layer of foam padding for excellent protection. Quilted mini diamond pattern 1" size. Nylon girth/billet straps. Washable. Available in Green, Black, Navy Blue, Red, White, Royal Blue, Maroon. SPECIFY COLOR.



**02-1345** QUILTED COTTON COMFORT SADDLE PADS

100% Cotton twill pad featuring an inner layer of foam padding for excellent protection. Quilted diamond pattern 2" size. Nylon girth/billet straps. Washable. Available in Green, Black, Navy Blue, Red, White, Royal Blue, Maroon. SPECIFY COLOR.



**02-1346** QUILTED COTTON COMFORT SADDLE PADS

100% Cotton twill pad features a shock absorbing insulation between layers. Your horse can tell the comfort difference. An inner layer of foam padding for excellent protection. Quilted diamond pattern 2" size. Washable. Available colors for Nylon girth



**02-1347** QUILTED COTTON COMFORT SADDLE PADS

100% Cotton twill pad features a shock absorbing insulation between layers. Your horse can tell the comfort difference. An inner layer of foam padding for excellent protection. Quilted diamond pattern 2" size. Washable. Available colors for Nylon girth / billet straps: Sky Blue, Green, Black, Red, Maroon and Royal Blue. SPECIFY COLOR. Available colors: Sky blue/sky blue trim, Red/black trim, Black/red trim, Grey/black trim, Sky Blue.



**02-1348** QUILTED COTTON COMFORT SADDLE PADS

100% Cotton twill pad features a shock absorbing insulation between layers. Your horse can tell the comfort difference. An inner layer of foam padding for excellent protection. Quilted mini diamond pattern 1" size. Washable. Available colors for Nylon girth / billet straps: Green, Black, Red, Sky Blue, Maroon and Royal Blue. SPECIFY COLOR.



**02-1349** QUILTED LEATHER COMFORT SADDLE PADS

Synthetic leather amara. Diamond pattern 2" size. Available colors for Nylon girth / billet straps: Green, Black, Red, Sky Blue, Maroon and Royal Blue. SPECIFY COLOR. Available colors: Red/black trim, Black/red trim, Grey/black trim, Sky Blue/ sky blue trim, Black/white trim, Green/white trim, Navy Blue /white trim, Red/white trim, White black trim, Royal Blue/white trim, Maroon/white trim . SPECIFY COLOR.



**02-1350** Hunting Hound Belt



**02-1351** Dog Belt



## Saddles



### 02-1352 SADDLES

Close Contact English Saddle. Ideal for jumping or riding on the flat. Made from premium quality leather. Includes safety stirrup bars and nylon reinforced billets. Fits almost any breed. (16 1/2", 17", 17 1/2")



### 02-1353 SADDLES

Close Contact English Saddle. Ideal for jumping or riding on the flat. Made from premium quality leather. Includes safety stirrup bars and nylon reinforced billets. Fits almost any breed. (16 1/2", 17", 17 1/2")



### 02-1354 SADDLES

Close Contact English Saddle. Ideal for jumping or riding on the flat. Made from premium quality leather. Includes safety stirrup bars and nylon reinforced billets. Fits almost any breed. (16 1/2", 17", 17 1/2")



### 02-1355 SADDLES

Close Contact English Saddle. Ideal for jumping or riding on the flat. Made from premium quality leather. Includes safety stirrup bars and nylon reinforced billets. Fits almost any breed. (16 1/2", 17", 17 1/2")



### 02-1356 SADDLES

Close Contact English Saddle. Ideal for jumping or riding on the flat. Made from premium quality leather. Includes safety stirrup bars and nylon reinforced billets. Fits almost any breed. (16 1/2", 17", 17 1/2")



### 02-1357 SADDLES



### 02-1358 CLOSE CONTACT ENGLISH SADDLE

Close Contact English Saddle. Ideal for jumping or riding on the flat. Made from premium quality leather. Includes safety stirrup bars and nylon reinforced billets. Fits almost any breed. (16 1/2", 17", 17 1/2")



### 02-1359 SADDLES

Close Contact English Saddle. Ideal for jumping or riding on the flat. Made from premium quality leather. Includes safety stirrup bars and nylon reinforced billets. Fits almost any breed. (16 1/2", 17", 17 1/2")



### 02-1360 SADDLES

Close Contact English Saddle. Ideal for jumping or riding on the flat. Made from premium quality leather. Includes safety stirrup bars and nylon reinforced billets. Fits almost any breed. (16 1/2", 17", 17 1/2")



## Horse Riding Gloves



### 02-1361 Spandex Kidskin

Made of the softest sweat proof leather, The spandex knitted elastic back has "quick grip" fasteners on the wrist band for easy on and off. Ladies one size fits all. Black or natural. Specify color.



### 02-1362 Leather Riding Gloves

These riding gloves are hand crafted and incredibly strong genuine lamb skin. Quick-grip closure. Leather reinforced wear points. Ladies: Small/medium, Large X-large. Brown or black. Men's: Medium/Large, Large/ X-large. Black only.



### 02-1363 Leather/Spandex Gloves

This popular glove offers close contact on the rein. Made of 4 way stretch spandex/spandex "massage action" material with soft, supple leather palm. Elastic wrist with "quick grip" tabs for easy on and off. Specify color. Burgundy, navy and black. One size fits all in child's, ladies or men's.



### 02-1364 Open Back Capeskin

These supple capeskin gloves feature open backs with adjustable "quick grip" fasteners. Black only. One size fits all in child's, ladies or men's size.



### 02-1365 Eshal Gloves

Palm-black ammara, back spandex.



### 02-1366 Riding Gloves

Palm made of cow (naked) brown, back made of spandex.



## Horse Riding Gloves



### 02-1367 Leather/Neoprene Gloves

Leather reinforced palm, elastic grip with quick grip closure. Available in blue color.



### 02-1368 Leather/Neoprene Gloves

Leather reinforced palm, elastic grip with quick grip closure. Available in burgundy color.



### 02-1369 Leather/Neoprene Gloves

Fine leather and cotton embroidery. Available in Small, Medium & Large sizes.



### 02-1370 Lambskin Gloves

For those who appreciate quality, these riding gloves are hand crafted and incredibly strong genuine lambskin. Leather reinforced wear points. Ladies: Small/medium, large/x-large. Brown or black. Men's: Medium/large, large/x-large. Black only.



### 02-1371 Leather/Neoprene Gloves

This new design offers warmth and flexibility on those cool days. Leather reinforced palm, elastic wrist with quick grip closure. Available in blue color.



## Splint Boots and Whips Crops & Bats



**02-1372**

Heavy rubber exterior and lined with PVC neoprene. Splint area protected with extra padding. Quick-grip closures. Has adjustment to fit many different size horses. For rear leg use. Available Sizes: Small, Medium, Large.

**02-1373**

Made with neoprene and velcro fasteners. Provides extra padding to the tendon area from stick and ball without constricting the joint. Easy to use. Easy to wash. For front leg use. Available Sizes: Small, Medium, Large.



**02-1374**

Heavy rubber exterior and lined with PVC neoprene. Splint area protected with extra padding. Quick-grip closures. Has adjustment to fit many different size horses. For front leg use. Available Sizes: Small, Medium, Large.



**02-1376**

**02-1377**

**02-1378**

**02-1379**



**02-1375**

Kneepads for polo players- 2 strap velcro provides safety and comfort. Also features closed cell foam padding for the ultimate in protection. Also available with 3 strap velcro and buckles for extra strength.



# Surgical Forceps



**03-1380**

Halstead Mosquito Forcep Str/Cvd  
Size: 13cm



**03-1381**

Spencer Wells Forceps Str/Cvd  
Size: 12.5cm, 15cm, 18cm



**03-1382**

Crile Artery Forceps Str/Cvd  
Size: 14cm



**03-1383**

Rochester Pean Artery Forceps Str/Cvd  
Size: 16cm

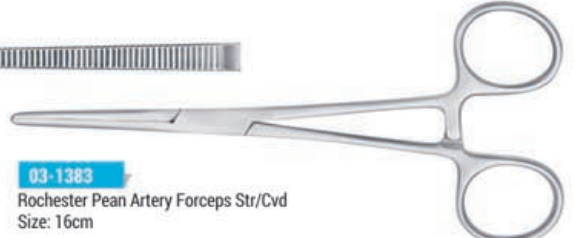

**03-1384**

Allis Tissue Forceps 2x3T, 3x4T, 4x5T  
Size: 15cm



**03-1385**

Bowel Clamps Doyen Atraumatic  
Size: 17cm, 24cm



**03-1386**

Babcock Tissue Forceps  
Size: 16cm, 20cm

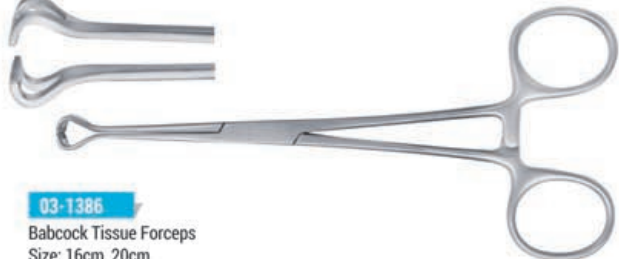

**03-1387**

Ballenger Sponge Serrated Forceps Str/Cvd  
Size: 18cm

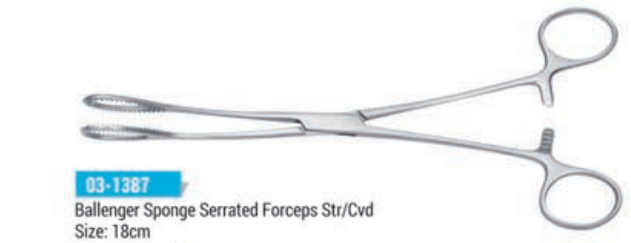

**03-1388**

Baby Mixer Forceps  
Size: 14cm, 18cm



## Towel Clamps



**03-1389**

Backhaus Towel Clip  
Size: 9cm, 11cm, 13cm



**03-1390**

Jones Towel Clip  
Size: 9cm



**03-1391**

Lorna Towel Clip  
Size: 10cm, 14cm



## Dressing and Tissue Forceps



03-1392

- (a) Adson Serrated Forceps Size: 12.5cm
- (b) Adson Brown Dissecting Forceps Size: 12.5cm
- (c) Adson Dissecting Forceps 1/2 Teeth Size: 12.5cm



03-1393

Lanes Dissecting Forceps 1/2 Teeth  
Size: 15cm



03-1394

Surgical Dressing Forceps  
Sizes: 13cm, 14cm, 16cm, 18cm, 20cm, 25cm, 30cm



03-1395

Standard Tissue Forceps 1/2 Teeth  
Sizes: 13cm, 14cm, 16cm, 18cm, 20cm, 25cm, 30cm



03-1396

Russian Tissue Forceps  
Sizes: 16cm, 20cm



## Hollowares



03-1397

Kidney Dishes  
Sizes: 6", 8", 10" 12"



03-1398

Instrument Steel Boxes Box with Lid  
250mm x 120mm x 50mm  
300mm x 150mm x 50mm  
400mm x 200mm x 70mm



03-1399

Lotion Bowls  
200mm x 100mm x 40mm  
Sizes: 6", 8", 10"

## Scalpel Handles

03-1400

Scalpel Handle No. 3



03-1401

Scalpel Handle No. 4







## Needle Holders



**03-1402**  
Mayo-Hegar  
14cm, 16cm, 18cm, 20cm

**03-1404**  
Derf, Size: 12cm

**03-1406**  
Mathieu 14cm, 16cm, 18cm



**03-1403**  
Crile-Wood, Size: 15cm

**03-1405**  
Ryder, Size: 15cm

**03-1407**  
Olsen Hegar 14cm, 17cm, 19cm

## Scissors

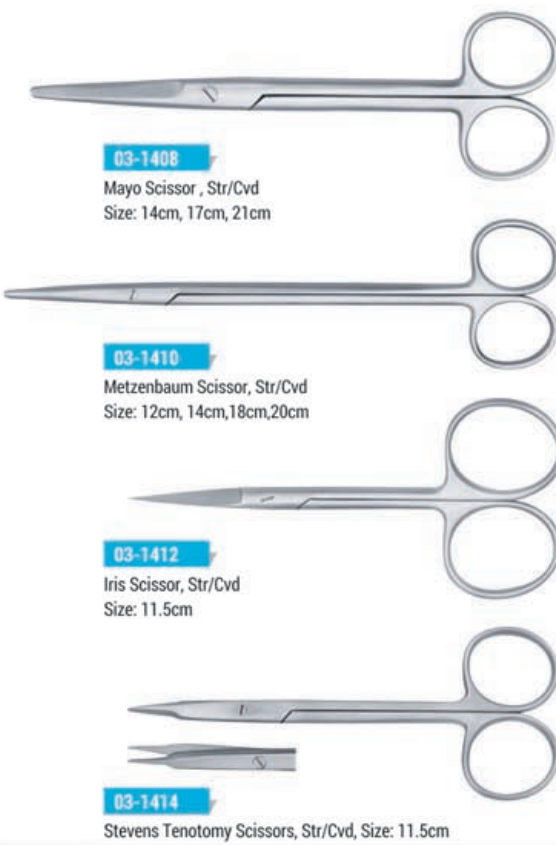

**03-1408**  
Mayo Scissor , Str/Cvd  
Size: 14cm, 17cm, 21cm

**03-1410**  
Metzenbaum Scissor, Str/Cvd  
Size: 12cm, 14cm, 18cm, 20cm

**03-1412**  
Iris Scissor, Str/Cvd  
Size: 11.5cm

**03-1414**  
Stevens Tenotomy Scissors, Str/Cvd, Size: 11.5cm

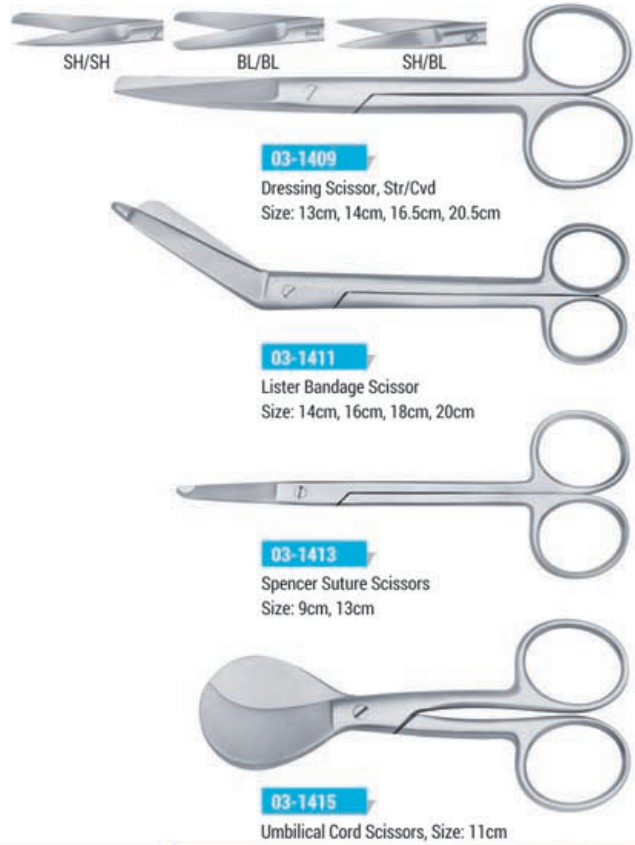

SH/SH      BL/BL      SH/BL

**03-1409**  
Dressing Scissor, Str/Cvd  
Size: 13cm, 14cm, 16.5cm, 20.5cm

**03-1411**  
Lister Bandage Scissor  
Size: 14cm, 16cm, 18cm, 20cm

**03-1413**  
Spencer Suture Scissors  
Size: 9cm, 13cm

**03-1415**  
Umbilical Cord Scissors, Size: 11cm



## Retractors



**03-1416** Balfour Abdominal Retractor  
Balfour Abdominal Retractor 180mm Opening  
Balfour Baby Abdominal Retractor 90mm Opening

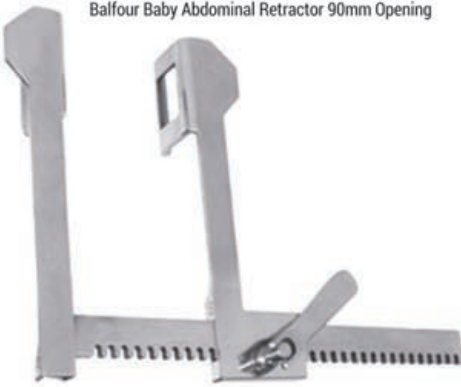

**03-1419** Finochietto Rib Retractor  
Finochietto Rib Retractor Small 75mm Spread  
Finochietto Rib Retractor Large 140mm Spread

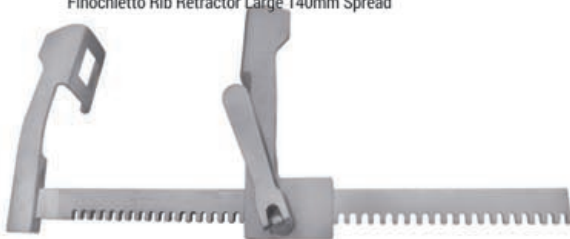

**03-1421** Rib spreader Stainless steel  
Rib spreader Stainless steel Standard Size,  
blades 48mm deep x 65mm wide, 12° Spread, Curved arms



**03-1423** Morris Single Ended Retractors  
Morris Single Ended Retractor 5.2x3.8cm  
Morris Single Ended Retractor 5.2x5.2cm  
Morris Single Ended Retractor 5.2x6.4cm



**03-1417** Gelpi Retractors  
Mini Gelpi Retractor 90cm Gelpi Retractor 14cm 5.5"  
Gelpi Retractor 18cm 7" Weitlaner Retractor 6.5" Sharp Teet



**03-1418** Travers Retractor  
Travers 4x5 Teeth Retractor 20cm 8"



**03-1420** Weitlaner Retractors  
Weitlaner Retractor 7" Blunt Teeth Small Weitlaner  
Retractor 5.5" Sharp 3x4 Teeth Weitlaner Retractor 6.5" Blunt 3x4 Teeth



**03-1422** Senn Miller Retractors  
Senn Miller Retractor Blunt Teeth  
Senn Miller Retractor Sharp Teeth



**03-1424** Langenbeck Retractors  
Langenbeck Retractors 2.3x0.7cm  
Langenbeck Retractors 4.4x1.3cm  
Langenbeck Retractors 6.5x2.5cm  
Langenbeck Retractors 9.0x2.0cm



## Equine Surgical Instruments



03-1425

Cervix Forceps Equine Related Size 21" 53cm Easy to hold pistol handle with step locking ratchet mechanism and easy to release one click hook for ease of operation.

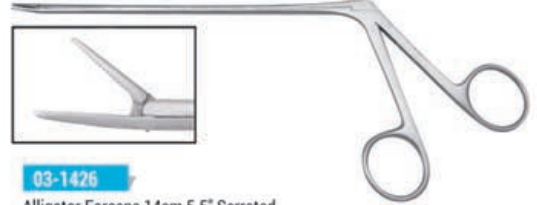

03-1426

Alligator Forceps 14cm 5.5" Serrated



03-1427

Jackson uterine biopsy forceps

Stainless steel biopsy forceps has a 4mm x 28mm cutting area and 60cm long shaft. Popular for equine uterine biopsy



03-1428

Mare Biopsy Punch 26". Mare Uterine Biopsy Punch is an equine reproduction product for use in artificial insemination in horses. Mare biopsy punch with pistol grip handle and locking nut. (26") Long

## Miscellaneous Instruments



03-1429

Equine Stomach Pump

Size: 15.5 (Small) and 21 (Large).  
Supplied with 10 feet long tube



03-1430

Mini fibre optic Otoscope with Pouch



03-1431

Mole Trap



03-1432

Digital Thermometer C or F  
(Picture for illustration Purposes only)



03-1433

Embryotome Thygesen 85 cm



03-1434

Ear Syringe Complete:  
50ml, 75ml, 100ml, 150ml, 200ml



# Root Elevators



03-1435

Winged Elevators Standard Stubby 1mm-6mm



03-1436

Winged Elevators Standard Handle 1mm-6mm



03-1437

Straight Root Tip Elevator Standard Handle



03-1438

Periosteal Elevator Standard Handle



03-1439

Straight Root Tip Stubby Handle Elevators 1mm-2mm(Also Set of 2)



03-1440

Set of Winged Tip Elevators in sizes 1-4mm



03-1441

Set of Winged Tip Elevators in sizes 1-4mm



## Root Elevators



Right Angle

03-1442

Canine Root Elevator



Straight



Left Angle



03-1443

Cryer Elevator Set of 2

Left Angle



Right Angle



03-1444

Coupland Dental Elevator Set of 1mm-3mm(Set of 3)



03-1445

Elevator Sterilization Tray



03-1446

Elevator Sterilization Tray



## Scalers & Probes for Cats & Dogs



03-1447

Explorer/Measuring Probe Standard



03-1448

Periosteal Elevator Double Ended



03-1449

Jaquette Supragingival Scaler Double Ended



03-1450

Subgingival Curette



03-1451

Sickle Scaler Normal

## Specialized Dog Scalers



03-1452

McCall Dog Scaler, Dual Ended



03-1453

Kaplan Dog Scaler



03-1454

Dog Scaler Left



03-1455

Dog Scaler Right



03-1456

Periosteal Elevator No 9



03-1457

Examination Mirror Single Ended used for Small Animal Dentistry

## Dental Extraction Forceps & Mouth Retractors



03-1458

Extraction Forceps Angled Jaw, 12 cm



03-1459

Tooth Extraction Forceps, Angled & Straight Jaw, 2.5 cm



03-1460

Small Animal Forceps Fragment, 16.5 cm



03-1461

Root Tip Extraction Forcep, 15 cm



03-1462

Cheek Retractor Minessota



03-1463

Small Animal Mouth Gag Openers (Set of 5 Gags)

- Mouth Gag for Dog 16 cm
- Mouth Gag for Dog 12.7 cm
- Cat/Dog 8.8cm
- Cat/Dog 5.5 cm
- Special Cat 2.7 cm



## VETERINARY INSTRUMENTS CATALOGUE



Sublime Chowk, Wazirabad Road, Sialkot - Pakistan

Tel: 0092-52-3254077-78

Fax: 0092-52-3254079

E-mail: bak@bakind.com

Web: www.bakind.com

### MEXICO OFFICE

**6b INVENT**  
G E R M A N Y S.A. DE C.V.



IMPORTADORA Y EXPORTADORA DE INSTRUMENTAL MEDICO , DENTAL

MIGUEL LAURENT # 616 COL. DEL VALLE C.P. 03100 MEXICO, D.F. BENITO JUAREZ

TEL. 0052-55-5674-2601, 0052-55-3330-7328 Y 55-3330-7329 FAX: 0052-55-5674-2597

E-mail: ventas@6binventgermany.com • anwarhtariq@hotmail.com • www.6binventgermany.com • www.6binvent.com

### GERMANY OFFICE:

6b Invent Deutschland Ug

Siemensstrabe 11, 75334

Straubenhardt Germany

E-mail: service@6bi.de

www.6bi.de

### BRAZIL OFFICE:

6b Invent Germany Brasil

235, Rua 7 De Abril, Sala 507

5 Piso – Republica 01043-000

Sao Paulo - Brasil